

Warnings

- This appliance is designed for home air conditioning and must not be used for other purposes.
- It is dangerous to modify or alter the characteristics of the appliance in any way.
- The appliance must be installed in conformity with legislation in force in the country concerned.
- If the appliance requires repair, contact a Service Centre authorised by the manufacturer only. Repairs carried out by unauthorised personnel may be dangerous.
- This air conditioning unit must be used by adults only. Never allow children to play with the appliance.
- The appliance must be connected to an efficient earth system. Have your electrical circuit checked by a qualified electrician.
- If the power cable is damaged, it must be replaced by a qualified professional authorised by the manufacturer only.
- Do not use extension cables.
- Before cleaning or maintenance operations, always unplug the appliance from the mains socket.
- Do not move the appliance by pulling the power cable.
- Do not install the appliance in rooms containing gas, oil or sulphur. Do not install near sources of heat.
- Do not rest heavy or hot objects on top of the appliance.
- Clean the dust filter at least once a week.
- Avoid using heating appliances near the air conditioning unit.
- Always transport the appliance upright or resting on one side, with short movements only. Before moving the appliance, empty the condensate pan in the indoor unit and the base of the outdoor unit.
After moving the appliance, wait at least 1 hour before starting it.
- The materials used for packaging can be recycled. You are therefore recommended to dispose of them in special differentiated waste collection containers.
- R407c is a refrigerant that complies with the EEC standards on environmental protection. Therefore, do not perforate the appliance's refrigerant circuit. At the end of the working life of the appliance the unit should be taken to a recycling centre for disposal of the refrigerant.

What are the Pinguino and SuperPinguino?

During the summer, you feel comfortable at a temperature of between 24 and 27°C with a relative humidity of about 50%.

An air conditioning unit removes excess moisture and heat from the room where it is located. Compared with installed models, portable air conditioning units have the advantage that they can be moved from one room to another in the home or be transported from one building to another.

Hot air from the room is passed through a coil cooled by refrigerant gas. Excess heat and moisture are removed before the air is re-emitted into the room.

In packaged models (Pinguino), a small part of this air is used to cool the refrigerant gas and then, when hot and damp, is discharged outside.

In split models (SuperPinguino), the circuit is cooled using air from the outside.

All Pinguino and SuperPinguino models can also be used in fan-only mode.

ENGLISH

DESCRIPTION OF THE APPLIANCE

- 1 Indoor unit
- 2 Indoor unit handle
- 3 Cold air outlet grille
- 4 Operating status indicator LED
- 5 Filter
- 6 Air intake grille
- 7 Power cable
- 8 Button for emptying the pan
- 9 Connection sheath
- 10 Castor wheels
- 11 Outdoor unit
- 12 Outdoor unit handle
- 13 Condenser air outlet grille
- 14 Red light (dehumidifying function)
- 15 Yellow light (fan function)
- 16 Green light (air-conditioning/dehumidifying function)
- 17 Manual operation button
- 18 Remote control receiver
- 19 Connection
- 20 Suckers
- 21 Castor locks

Preparing for use

POSITIONING THE INDOOR UNIT

Install the appliance inside the room being air-conditioned. In general, near a window or door. In any case, near a perimeter wall.

The indoor unit must be positioned on an even surface, where possible on a table, or other piece of furniture (see Figures 1 and 2). There must be no obstructions to the air intake (rear grilles **6**) and outlet (top outlet grille **3**) on the indoor unit.

NOTE: The appliance must be positioned at least 20/30cm from any walls.

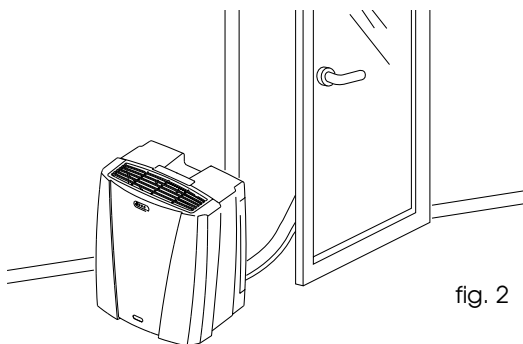
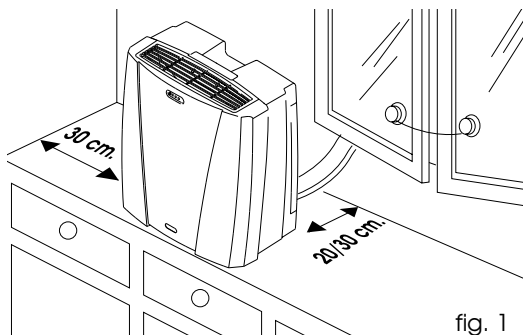

POSITIONING THE CONNECTION SHEATH

The sheath **9** connecting the outdoor and indoor units can be passed through the gap in a window or door left ajar; use the suckers **20** to prevent them from opening further.

Permanent installation is possible by purchasing the accessories and wall brackets from a De'Longhi service centre or reseller.

USING THE QUICK COUPLINGS

As an alternative to the methods described above, the sheath connecting the outdoor and indoor units can be passed through an approx. 9cm diameter hole in a perimeter wall.

In this case, the outdoor unit couplings must be disconnected as follows:

- 1) Unplug the appliance from the mains supply.
- 2) Remove the handle by unscrewing the 4 metric screws, then, to remove the cover, unscrew the remaining 4 self-threading screws (see Figure 3).
- 3) Disconnect the electrical connectors (Figure 4).

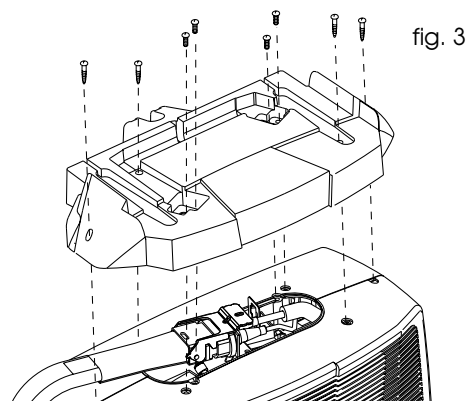

- 4) Disconnect the water tubing from the quick coupling, pressing the locking ring and pulling out the plastic tube (Figure 4).

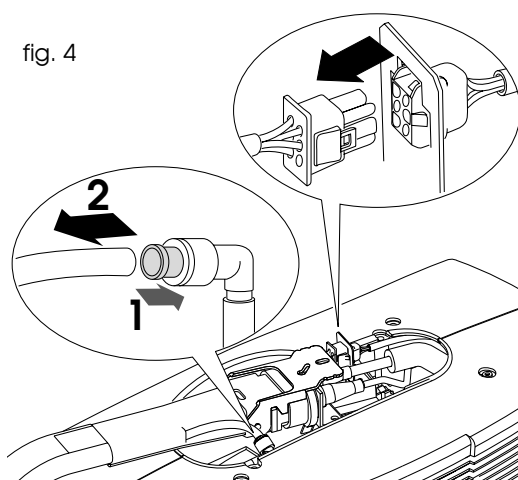

- 5) Disconnect the hoses using the handle on the quick couplings, until completely open-

Preparing for use

ned, then move the ring on the connection back to completely disconnect the flexible sheath (Fig. 5).

Avoid tight curves in the connection sheath.

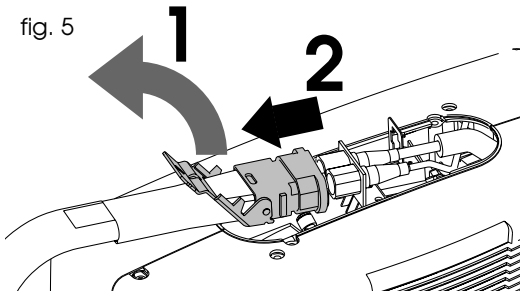

RECONNECTING THE SHEATH

To reconnect the ends of the connecting sheath to the indoor unit, repeat operations 1, 2, 3, 4 and 5 in reverse order, observing the following precautions:

- Before passing the sheath through the hole in the wall, the threaded ends of the quick couplings should be protected using the brass cap supplied or paper tape.
- Insert the female part of the sheath into the male part, pulling back the ring and inserting it fully, then close the locking lever.

After having connected the two refrigerant fittings, attach the electrical connectors and the water tubing, inserting it in the corresponding coupling and pushing it all the way in.

Warning

Have all the operations involving the disconnection and connection of the quick couplings performed outdoors, by qualified personnel.

POSITIONING THE OUTDOOR UNIT

The outdoor unit can be placed on a terrace or balcony (Fig. 6).

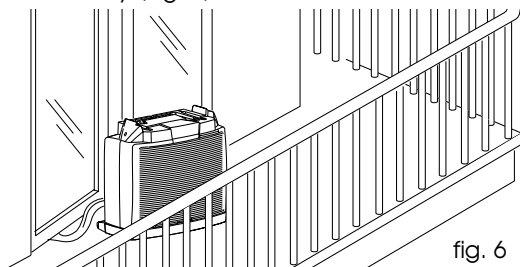

The outdoor unit can also be installed on a window sill, if this faces onto a balcony (Fig. 7)

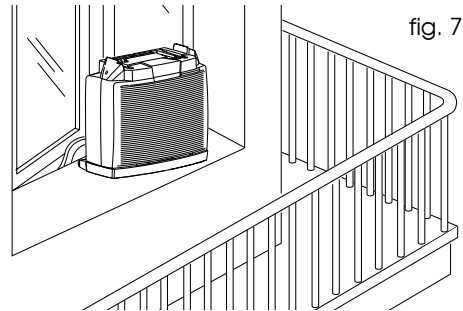

Always lock the 2 outer wheels using the castor locks supplied.

De'Longhi is not liable for any damage to people or things caused by the positioning of the unit in a manner not compliant with the basic standards of safety.

The outdoor unit may be installed above or at the same level as the indoor unit, provided that the difference in level is not greater than 1.5m. The air intake and outlet of the outdoor unit must be kept clear of obstacles. Leave at least 6cm between the wall and the rear of the appliance. The condensate forming during operation in air-conditioning mode (in summer) is almost totally eliminated via evaporation from the outdoor unit. In particular cases, if there is excessive humidity, the condensate is drained through a hole in the base. To drain the water that forms, use the condensate drain connector **19** supplied, which must be fitted on the base of the outdoor unit (see Figure 8). This can then be connected to a rubber hose. The outdoor unit should be protected from the sun, rain, snow and drips from the roof.

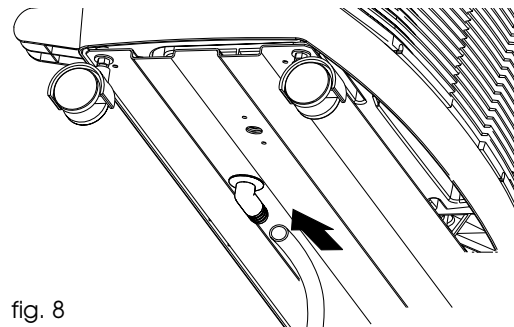

ENGLISH

Buttons and indicators on the indoor unit

BUTTONS AND INDICATORS ON THE INDOOR UNIT

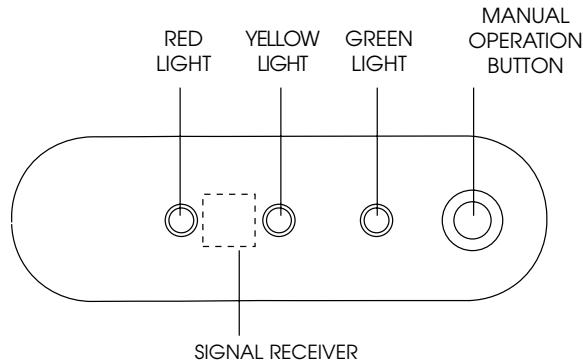

INDICATOR LIGHTS

These turn on according to the function selected or indicate any operating anomalies.

FUNCTION	RED LIGHT	YELLOW LIGHT	GREEN LIGHT
OFF	-	-	-
AIR-CONDITIONING	-	-	on
DEHUMIDIFYING	on	-	on
FAN	-	on	-
SMART	Once having selected this function, all the indicator lights come on for a few seconds while the controller decides the operating mode (air-conditioning, dehumidifying, fan).		
TIMER	The indicator lights are all on, when the machine is off, if the TIMER function has been set.		

ANOMALY	RED LIGHT	YELLOW LIGHT	GREEN LIGHT
ALARM	flashing	flashing	flashing

see "troubleshooting" on page 32

MANUAL OPERATION

This operating mode is to be used only when the remote control is inoperative (broken, lost, flat batteries). Press the manual operation button until selecting the desired function (air-conditioning, dehumidifying, fan, smart, off).

Refer to the indicator lights and the table above to identify the mode selected.

For each mode selected, the appliance will automatically choose the optimum values for maximum comfort.

This appliance is fitted with a safety system that prevents the compressor from starting until at least 3 minutes have elapsed since last started.

The remote control

THE REMOTE CONTROL

Inserting the batteries

- Remove the protective cover (see Figure 9).
- Insert two new batteries (not rechargeable) making sure the (+) and (-) are in the correct positions.
- Replace the cover, sliding it into the initial position.
- The display will show, for a few moments, all the symbols relating to the remote control.

NB: Alkaline batteries should be used (LR03).

When replacing or disposing of the remote control, the batteries must be removed and disposed of according to the legislation in force, being harmful to the environment.

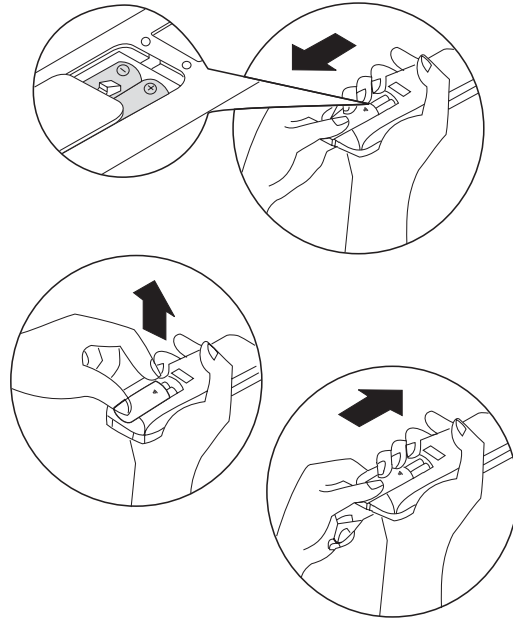

fig. 9

When the remote control unit batteries are replaced, the air-conditioning indicator ☼ and heating indicator 🔥 will flash alternately on the remote control unit liquid crystal display.

To set the remote control unit correctly, while ☼ is displayed, press any button.

If no button is pressed within 12 seconds, the remote control unit will also make the heating 🔥 mode available, despite the fact that this function is not available with this appliance.

If the remote control is not be used for a certain length of time, remove the batteries.

CORRECT USE

- Aim the remote control at the indicator lights on the air-conditioner (Fig. 10).
- Maximum distance: around 7 metres (without obstacles between the remote control and the receiver).
- The remote control should be handled with **extreme care and respect**: without dropping it, without exposing it to direct sunlight or near sources of heat.

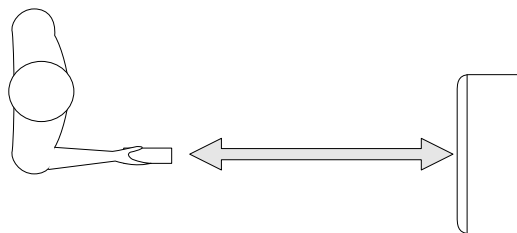
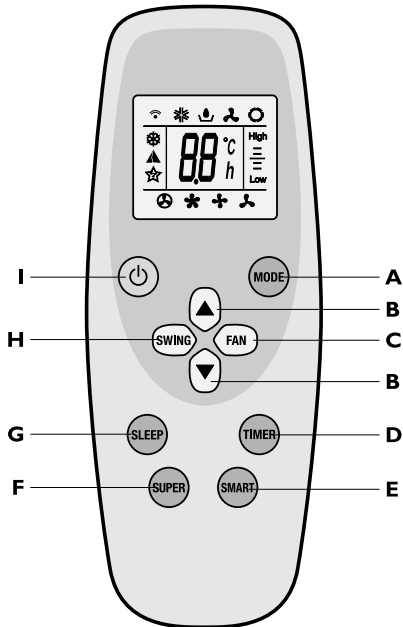

fig. 10

Description of the remote control

THE REMOTE CONTROL



THE DISPLAY

- Signal transmission
- Air-conditioning indicator
- Dehumidifying indicator
- Fan indicator
- Heating indicator (mode not supported by this appliance)
- SLEEP indicator
- SUPER air-conditioning indicator
- SMART indicator
- SLEEP indicator
- Automatic fan speed
- High fan speed
- Medium fan speed
- Low fan speed

High Used to set the temperature in SMART mode or the level of dehumidification.

Low

A. MODE button

Selects the operating mode (air conditioning, dehumidifying, fan).

B. Buttons for SETTING THE ROOM TEMPERATURE

Set room temperature or program the timer.

C. FAN button ()

Sets fan speed to automatic, high, medium or low in sequence.

D. TIMER button

Sets or cancels the timer.

E. SMART button ()

When this button is pressed, the appliance automatically establishes the most suitable operating mode for maximum comfort.

F. SUPER button ()

Starts or stops rapid cooling (in the rapid cooling mode, the fan operates at high speed with the temperature automatically set to 18°C).

G. SLEEP button ()

Sets or cancels the automatic SLEEP function.

H. SWING button





(not enabled on this model)

I. ON/OFF button

Press this button to turn the appliance on and off. NB: the settings are displayed even when the air conditioner is off.

Functions

AIR-CONDITIONING MODE





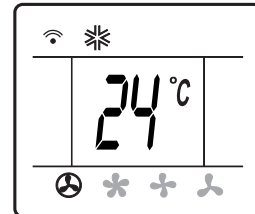



- Press the  button to turn the appliance on.
- A beep indicates that the air-conditioning unit is on and the  symbol flashes on the display.
- Press the MODE button a number of times until the air-conditioning symbol  appears on the display.
- Now set the temperature using the   buttons.
- To select fan speed, press the FAN button repeatedly until the required fan speed is selected (automatic, high, medium, low).

NB: in air-conditioning mode, the appliance automatically removes excess moisture from the atmosphere.



ENGLISH

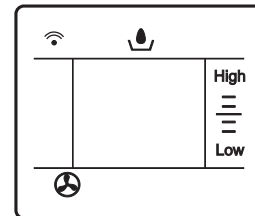

DEHUMIDIFYING MODE

- Activate this function when humidity is high.
- Press the  button to turn the appliance on. A beep indicates that the air-conditioning unit is on and the  symbol flashes on the display.
- Press the MODE button a number of times until the dehumidifying symbol  appears on the display.
- Use the buttons   to set the required level of dehumidification. The  symbol is displayed.
- Press the  button to increase the level of dehumidification and the  button to reduce it.
- In dehumidifying mode, fan speed is selected by the appliance automatically.



FAN MODE

On humid but not particularly hot days, the fan function alone may be adequate.

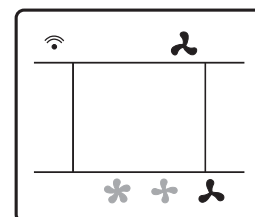

- Press the  button. A beep indicates that the air-conditioning unit is on and the  symbol flashes on the display.
- Press the MODE button a number of times until the fan symbol  appears on the display.
- Once fan mode has been selected, press the FAN button until the required speed is reached (low, medium, high).





Functions

SMART MODE

In SMART mode, the air-conditioning unit decides the best way to operate to guarantee maximum comfort.

- Press the  button to turn the appliance on. A beep indicates that the air-conditioning unit is on and the  symbol flashes on the display.
- Press the SMART button. The appliance functions automatically and the  symbol appears on the display.

NB: in SMART mode, the temperature is controlled automatically. However, if the required temperature has not yet been reached, it can be reduced or increased by a maximum of 2°C by pressing the   buttons.



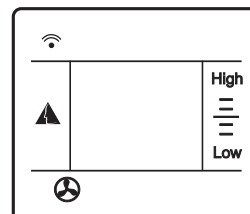

The appliance automatically establishes the operating mode (air-conditioning, dehumidifying, fan) and the optimum fan speed.



AUTOMATIC SLEEP MODE

The automatic SLEEP mode is ideal for the night-time as it enables operation of the air-conditioning unit in any of the modes (air-conditioning, dehumidifying, fan or SMART) to be gradually reduced until it shuts down completely (after eight hours).

To select SLEEP mode, proceed as follows:

- Press the  button to turn the appliance on.
- A beep indicates that the air-conditioning unit is on and the  symbol flashes on the display.
- Press the MODE button a number of times until the symbol of the function required appears on the display.
- Then select the required temperature by pressing the   buttons.
- Now press the SLEEP button to set the night function. The  symbol is displayed. Press the SLEEP button again to go back to the previous mode. In this mode, the fan operates at low speed.

The SLEEP function maintains the room temperature at the optimum level, avoiding excessive increases or drops in the temperature, with silent operation.

The flow of air decreases, while the room temperature is varied gradually according to the comfort requirements: increases of 1°C after 60 minutes and 2°C after 2 hours (it switches off altogether after eight hours).

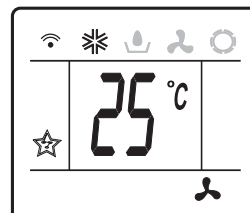



Functions

SUPER MODE

SUPER mode is used to turn rapid cooling on or off. The fan is set to high speed and the temperature is automatically set to 18°C.

To select SUPER mode, proceed as follows:

- Press the  button to turn the appliance on. A beep indicates that the air-conditioning unit is on and the  symbol flashes on the display.
- Press the SUPER button to set the mode. The  symbol is displayed.
- To go back to the previous mode, press the SUPER button again.

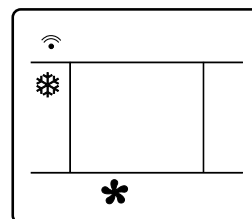



ENGLISH



PROGRAMMING THE TIMER

After selecting the required operating mode, activate the timer by pressing the TIMER button when you go out in the morning to obtain a comfortable room temperature for the time you return home.

Programming shut-down

- With the air-conditioning unit on, press the TIMER button. The time is displayed and the "h" symbol flashes. Set the time when you want the appliance to go off using the   buttons (from 30 minutes to 24 hours).
- Press the TIMER button again to confirm the selection. A countdown of the time left is displayed.
- At the end of the set time the appliance switches off automatically. During the first ten hours, you can select half hour intervals. For times greater than ten hours, one hour intervals can be selected.
- To cancel the set time, press the TIMER button again. You will hear a beep.

Programming start-up

- With the air-conditioning unit off, press the TIMER button. The time is displayed and the "h" symbol flashes. Set the time when you want the appliance to come on using the   buttons (from 30 minutes to 24 hours).
- Press the TIMER button again to confirm the selection. The three indicator lights on the air-conditioning unit come on.
- At the end of the set time the appliance switches on automatically. During the first ten hours, you can select half hour intervals. For times greater than ten hours, one hour intervals can be selected.
- To cancel the set time, press the TIMER button again. You will hear a beep and the three indicator lights on the air-conditioning unit will go off.

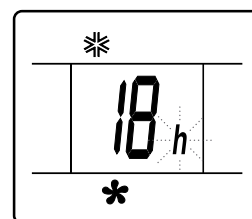

Tips

ELECTRICAL CONNECTIONS

Before plugging the appliance into the mains socket, check that:

- the mains power supply corresponds to the value indicated on the rating plate on the rear of the appliance;
 - the mains socket and electrical circuit are adequate for the load;
 - the mains socket matches the plug. If this is not the case, have the plug replaced;
 - the mains socket is adequately earthed.
- Failure to follow these important safety instructions absolves the manufacturer of all liability.**

The power cable must be replaced by a qualified professional only.

ONE LAST LOOK AT THE ROOM

To get the best from your air conditioning unit, follow these recommendations:

- close the windows and doors in the room to be air conditioned. The only exception is in the case of installation through a window, when the latter must remain ajar.



Close the windows

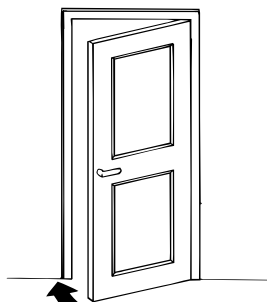

Close the doors

- Protect the room from direct exposure to the sun by partially closing curtains and/or blinds to make the appliance much more economical to run;

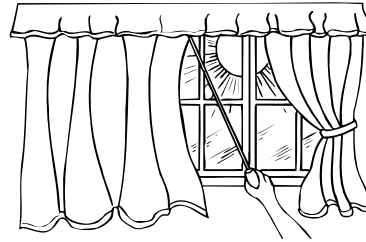

Close the curtains



Lower the blinds

- Never rest objects of any kind on the air conditioning unit;
- Never obstruct the air intake or outlet;
- Make sure there are no sources of heat in the room.

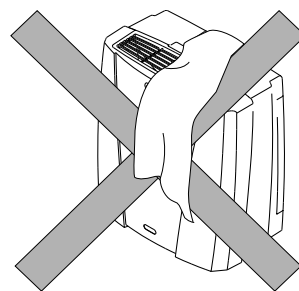

do not cover

IN THIS WAY, YOUR AIR-CONDITIONER IS READY FOR OPERATION.

This appliance is fitted with a safety system that prevents the compressor from starting until at least 3 minutes have elapsed since last stopping.

Cleaning

Before cleaning or maintenance, turn the appliance off by pressing the “OFF” button on the remote control ON/OFF and always unplug the appliance from the mains socket.

CLEANING

You should clean the appliance with a slightly damp cloth then dry with a dry cloth. For safety reasons, never wash the air conditioning unit with water.

Precautions

Never use petrol, alcohol or solvents to clean the appliance. Never spray insecticide liquids or similar.

CLEANING THE AIR FILTERS

To keep your air conditioning unit working efficiently, you should:

Clean the dust filter every week

The filters are fitted on the two intake grilles on the indoor unit. The grilles house the filters.

To clean the filters, proceed as follows

Remove the dust filters from the intake grilles (Fig. 11).

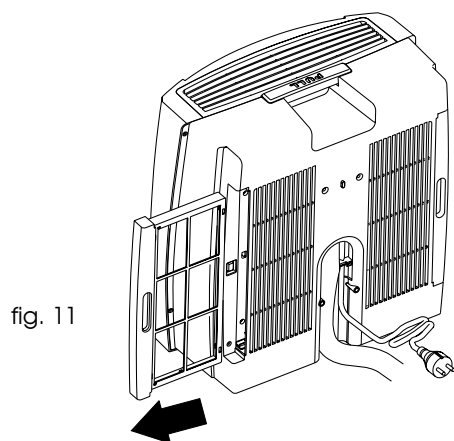

fig. 11

Use a vacuum cleaner to remove the dust collected on the dust filter.

If they are very dirty, immerse in warm water and rinse a number of times.

The water should never be hotter than 40°C.

After washing, leave the filters to dry, then replace them.

START OF SEASON CHECKS

Make sure the power cable and plug are undamaged and the earth system is efficient. Follow the installation instructions precisely.

END OF SEASON OPERATIONS

Before moving the appliance, empty the pan by holding the button **8** on the appliance until hearing the “gurgling” of the pump.

Warning: the water is drained outside from underneath the condensing unit, located outside.

Clean the dust filters and dry carefully before putting them back.

Cover the appliance with a plastic bag to stop it being covered in dust.

Troubleshooting

TROUBLESHOOTING

If something is not working, the problem may at times be simple to resolve. Carefully check these brief instructions before contact your local Authorised Service Centre.

PROBLEM	CAUSE	REMEDY
The air-conditioner doesn't work	<ul style="list-style-type: none"> no electricity it is not plugged into the mains the timer is set incorrectly 	<ul style="list-style-type: none"> wait plug into the mains set the timer correctly
Insufficient cooling	<ul style="list-style-type: none"> air filter dirty room too hot temperature set incorrectly the air intake/outlet grilles are blocked 	<ul style="list-style-type: none"> clean the air filter wait for it to cool down set the temperature correctly clean the grilles
Particular odour in the room	<ul style="list-style-type: none"> air filter dirty 	<ul style="list-style-type: none"> clean the air filter
Water leaks from the indoor unit of the air-conditioner	<ul style="list-style-type: none"> incorrect installation of the appliance pump malfunction 	<ul style="list-style-type: none"> See page 22 to install the appliance correctly unplug the appliance and contact the service centre
The remote control indicator is weak or inexistent	<ul style="list-style-type: none"> flat batteries batteries inserted the wrong way round 	<ul style="list-style-type: none"> change the batteries check the polarity of the batteries (+) and (-)
The air conditioning unit does not operate for about three minutes after turning it on	<ul style="list-style-type: none"> the safety device has tripped 	<ul style="list-style-type: none"> wait for three minutes
The compressor switches on and off periodically	<ul style="list-style-type: none"> the air-conditioner is working in dehumidifying mode the antifreeze safety device has tripped 	
The three indicator lights flash	<ul style="list-style-type: none"> operating anomaly 	<ul style="list-style-type: none"> unplug the appliance, wait a few minutes and then turn the appliance on again. If the problem persists, contact the service centre.

SERVICE

If following these checks the malfunction remains, contact your nearest authorised service centre, specifying the model of the appliance and the type of defect.

Transport, filling, cleaning, recovery and disposal of refrigerant should be performed by a technical service centre appointed by the manufacturer only.
The appliance should be disposed of by a specialist centre appointed by the manufacturer only.

Warranty/technical specifications

WARRANTY AND TECHNICAL SERVICE

The conditions of the warranty and technical service are provided on the certificate supplied with your appliance.

LIMIT CONDITIONS	
Temperature in the room	21 ÷ 32°C
Outside temperature	21 ÷ 43°C

TECHNICAL SPECIFICATIONS

Power supply voltage	see rating plate
Max. power input during air conditioning	"
Max. power input during dehumidifying	"
Cooling capacity*	"
Number of fan speeds	3
Max. air flow-rate	250-350 m ³ /h

Dimensions of indoor unit:

• width	450 mm
• height	475 mm
• depth	255 mm
• weight	10 kg

Dimensions of outdoor unit

• width	570 mm
• height	542 mm
• depth	280 mm
• weight	30 kg

* Standard conditions:

Inside temperature	27°C
	47% relative humidity
Outside temperature	35°C
	41% relative humidity

ENGLISH

**R407c is a refrigerant that complies with the EU rules on the environment, therefore it is recommended to not perforate the unit's refrigerant circuit.
At the end of its working life, take the appliance to a special collection centre.**

ELECTRICAL CONNECTION (U.K. ONLY)

- A) If your appliance comes fitted with a plug, it will incorporate a 13 Amp fuse. If it does not fit your socket, the plug should be cut off from the mains lead, and an appropriate plug fitted, as below. **warning:** Very carefully dispose of the cut off plug after removing the fuse: do not insert in a 13 Amp socket elsewhere in the house as this could cause a shock hazard. With alternative plugs not incorporating a fuse, the circuit must be protected by a 15 Amp fuse. If the plug is a moulded-on type, the fuse cover must be re-fitted when changing the fuse using a 13 Amp Asta approved fuse to BS 1362. In the event of losing the fuse cover, the plug must NOT be used until a replacement fuse cover can be obtained from your nearest electrical dealer. The colour of the correct replacement fuse cover is that as marked on the base of the plug.
- B) If your appliance is not fitted with a plug, please follow the instructions provided below:

WARNING - THIS APPLIANCE MUST BE EARTHED

IMPORTANT

The wires in the mains lead are coloured in accordance with the following code:

Green and yellow	Earth
Blue	Neutral
Brown	Live



As the colours of the wires in the mains lead may not correspond with the coloured markings identifying the terminals in your plug, proceed as follows:

The green and yellow wire must be connected to the terminal in the plug marked with the letter E or the earth symbol  or coloured green or green and yellow.

The blue wire must be connected to the terminal marked with the letter N or coloured black.

The brown wire must be connected to the terminal marked with the letter L or coloured red.